

# RM84

## miniature relays

RM84







RM84...-01 (AC) ①



RM84...-01 (DC) ①



- Relays designed for continuous operation\*
- CTI 250 • Reinforced insulation • For PCB and plug-in sockets • AC and DC coils, insulation class F: 155 °C
- Available special versions: in transparent cover ①; with the increased dielectric strength of the contact clearance ② • Compliance with standards EN 60335-1, EN 45545-2 • Recognitions, certifications, directives: RoHS,     

### Contact data

Number and type of contacts		2 CO, 2 NO ②
Contact material		<b>AgNi</b> , AgNi/Au hard gold plating, AgSnO <sub>2</sub>
Rated / max. switching voltage	AC	250 V / 400 V
Min. switching voltage		5 V AgNi, 5 V AgNi/Au hard gold plating, 10 V AgSnO <sub>2</sub>
Rated load (capacity)	AC1	8 A / 250 V AC
	AC15	3 A / 120 V                      1,5 A / 240 V (B300)
	DC1	8 A / 24 V DC (see Fig. 3)
	DC13	0,22 A / 120 V                      0,1 A / 250 V (R300)
Motor load	acc. to UL 508	1/3 HP                      240 V AC, 3,6 FLA, single-phase motor ③
	AC3 acc. to IEC 60947-4-1	0,37 kW                      240 V AC, single-phase motor
Min. switching current		5 mA AgNi, 2 mA AgNi/Au hard gold plating, 10 mA AgSnO <sub>2</sub>
Max. make current		15 A AgSnO <sub>2</sub>
Rated current		8 A
Max. breaking capacity	AC1	2 000 VA
Min. breaking capacity		0,3 W AgNi, 0,05 W AgNi/Au hard gold plating, 1 W AgSnO <sub>2</sub>
Contact resistance		≤ 100 mΩ
Max. operating frequency	• at rated load AC1	600 cycles/hour
	• no load	72 000 cycles/hour

### Coil data

Rated voltage	50/60 Hz AC	12, <b>24</b> , 48, 60, 110, 115, 120, 220, <b>230</b> , 240 V
	DC	3, 5, 6, 9, <b>12</b> , 18, <b>24</b> , 36, 48, 60, 110 V
Must release voltage		AC: ≥ 0,15 U <sub>n</sub> DC: ≥ 0,1 U <sub>n</sub>
Operating range of supply voltage		see Tables 1, 2 and Fig. 4, 5
Rated power consumption	AC	0,75 VA
	DC	0,4 W

### Insulation according to EN 60664-1

Insulation rated voltage		400 V AC
Rated surge voltage		4 000 V    1,2 / 50 μs
Overvoltage category		III
Insulation pollution degree		3 250 V                      2 400 V
Flammability class		V-0                      for standard cover (no transparent), UL 94
Dielectric strength	• between coil and contacts	5 000 V AC                      type of insulation: reinforced
	• contact clearance	1 000 V AC                      type of clearance: micro-disconnection
		2 000 V AC                      contacts 2 NO, type of clearance: full-disconnection ②
	• pole - pole	2 500 V AC                      type of insulation: basic
Contact - coil distance		clearance: ≥ 10 mm                      creepage: ≥ 10 mm

### General data

Operating / release time (typical values)		AC: 7 ms / 10 ms                      DC: 7 ms / 3 ms
Electrical life (number of cycles)	• resistive AC1	> 10 <sup>5</sup> 8 A, 250 V AC
	• cosφ	see Fig. 2
	• DC L/R=40 ms	> 10 <sup>5</sup> 0,15 A, 220 V DC
Mechanical life (cycles)		> 3 x 10 <sup>7</sup>
Dimensions (L x W x H) / Weight		29 x 12,7 x 15,7 mm / 14 g
Ambient temperature (non-condensation and/or icing)	• storage	-40...+85 °C
	• operating	coil AC: -40...+70 °C                      coil DC: -40...+85 °C -20...+70 °C ①
Cover protection category		IP 40 ① or IP 67                      EN 60529
Environmental protection		RTII ① or RTIII                      EN 61810-1
Shock resistance		20 g
Vibration resistance	(NO/NC)	10 g / 5 g 10...150 Hz
Solder bath temperature		max. 270 °C
Soldering time		max. 5 s

The data in bold type relate to the standard versions of the relays. \*The relays are designed for continuous operation while maintaining the parameters declared in the data sheet. ① Special versions - relays in transparent cover (certifications cULus, EAC), only available with IP 40 and RTII, operating temperature -20...+70 °C. See "Ordering codes". ② Special versions - relays with two normally open contacts 2 NO, with increased contact gap - dielectric strength 2000 V AC, only available with DC coils. See "Ordering codes". ③ For single phase motors for 110-120 V AC do not use motors with higher FLA than given for 240 V AC.

# RM84

## miniature relays

### Mounting, sockets and accessories for relays

Relays **RM84** are designed for: • direct PCB mounting • plug-in sockets.

Sockets for RM84	Accessories			Additional equipment
	Retainer / retractor clips	Spring wire clips	Description plates	
<b>Screw terminals sockets</b> , 35 mm rail mount (acc. to EN 60715) or on panel mounting (one M3 screw)				
GZT80	GZT80-0040, GZP80-0400	GZM80-0041	GZT80-0035	M... ⑤, ZGGZ80 ⑦
GZM80	GZT80-0040, GZP80-0400	GZM80-0041	GZT80-0035	M... ⑤, ZGGZ80 ⑦
GZS80	GZS-0040	GZM80-0041	TR	M... ⑤, ZGGZ80 ⑦
GZF80	–	GZM80-0041	–	–
<b>Push-in terminals sockets</b> , 35 mm rail mount (acc. to EN 60715) or on panel mounting (one M3 screw)				
GZP80 ⑥	GZP80-0400, GZT80-0040	GZM80-0041	MP15	M... ⑤, ZGZP80-8, ZGZP80-2, ZGZP-2 ⑦
<b>Sockets for PCB</b>				
PW80	–	MH16-2	–	–
EW50	–	MP16-2 ⑧, MH16-2	–	–
EC 50	–	MP16-2 ⑧, MH16-2	–	–
GD50	–	MP16-2 ⑧, MH16-2, GD-0016	–	–

④ For relays in transparent cover: the distance at least 5 mm between the relays mounted side by side. ⑤ Sockets GZP80: wire connection - see page 7. ⑥ Signalling / protecting modules type M... - see page 10. ⑦ Interconnection strips ZGGZ80, ZGZP... - see pages 11-12. ⑧ Plastic clips MP16-2.

### Dimensions

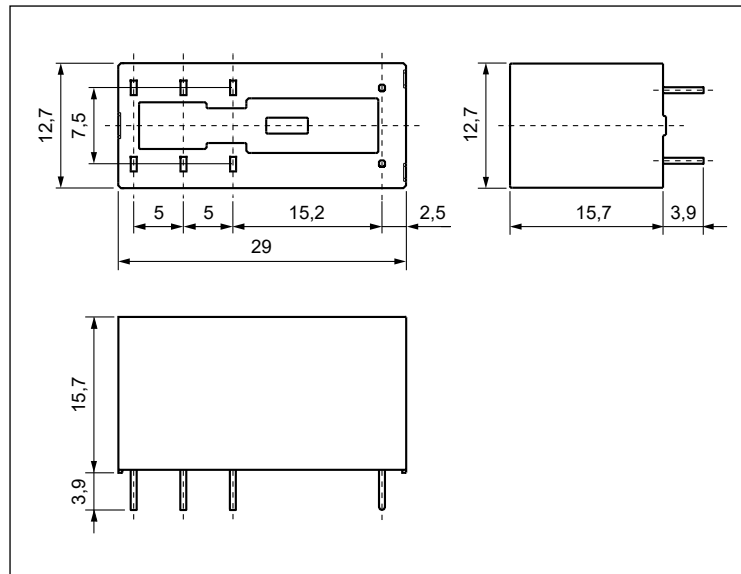

### Connection diagrams (pin side view)

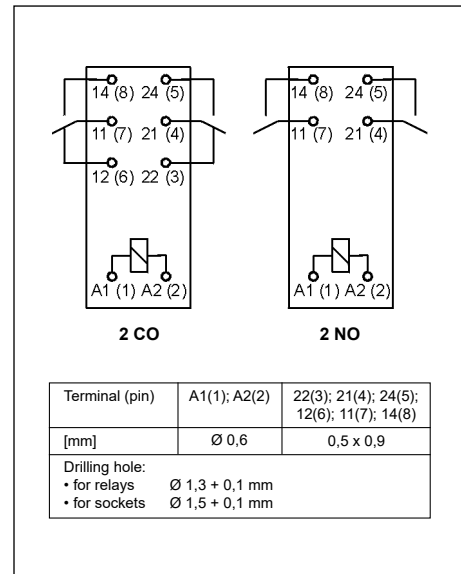

**Electrical life at AC resistive load.**  
Switching frequency: 600 cycles/hour

Fig. 1

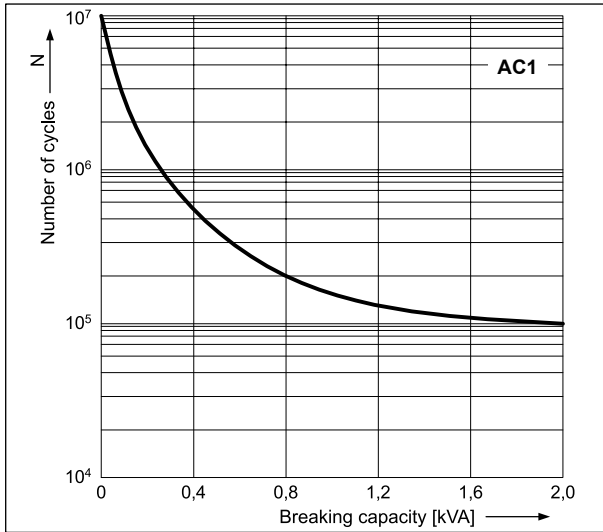

**Electrical life reduction factor at AC inductive load**

Fig. 2

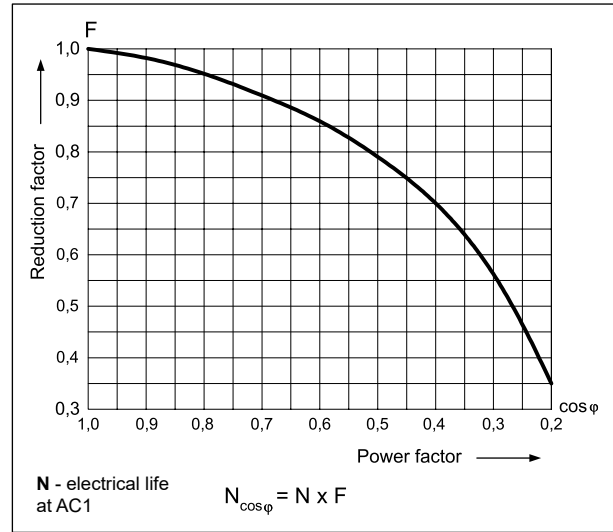

**Max. DC resistive load breaking capacity**

Fig. 3

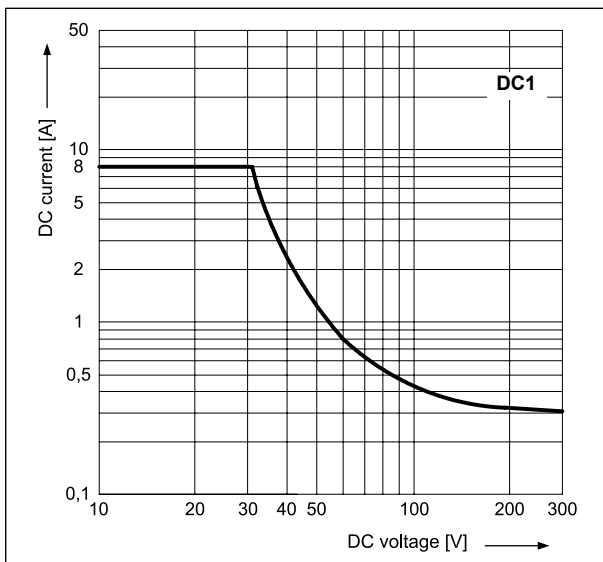

**Coil operating range - DC**

Fig. 4

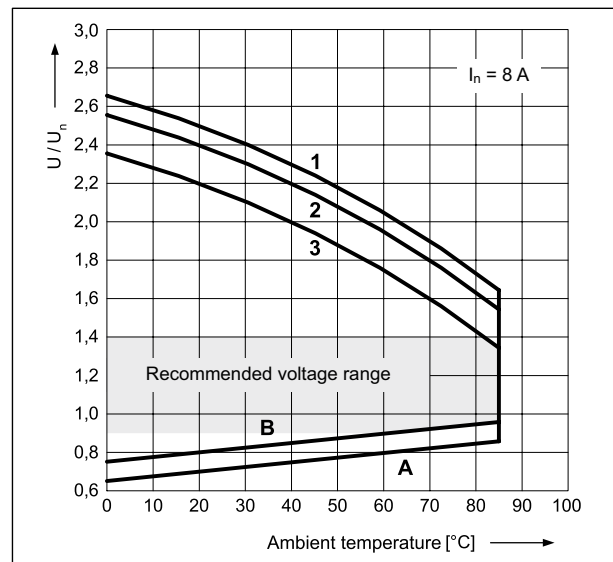

**Coil operating range - AC 50 Hz**

Fig. 5

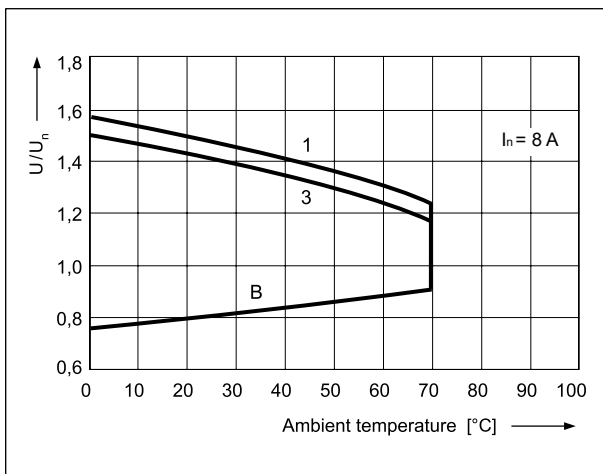

**Description of Fig. 4 and 5**

Using voltage other than the rated voltage may reduce the electrical life of the relay. Figure 4 shows the permissible voltage range for the relay coil, higher coil supply voltages may damage the coil insulation.

**A** - relations between make voltage and ambient temperature at no load on contacts. Coil temperature and ambient temperature are equal before coil energizing. Make voltage is not higher than the value read on Y axis (multiplication of rated voltage).

**B** - relations between make voltage and ambient temperature after initial coil heating up with 1,1  $U_n$ , at continues load of  $I_n$  on contacts. Make voltage is not higher than the value read on Y axis (multiplication of rated voltage).

**1, 2, 3** - values on Y axis represent allowed overvoltage on coil at certain ambient temperature and contact load:

- 1** - no load
- 2** - 50% of rated load in AC1 category
- 3** - rated load in AC1 category

**Coil data - DC voltage version**

Table 1

Coil code	Rated voltage V DC	Coil resistance at 20 °C Ω	Acceptable resistance	Coil operating range V DC ⑨	
				min. (at 20 °C)	max. (at 20 °C)
1003	3	22	± 10%	2,1	7,6
1005	5	60	± 10%	3,5	12,7
1006	6	90	± 10%	4,2	15,3
1009	9	200	± 10%	6,3	22,9
<b>1012</b>	<b>12</b>	<b>360</b>	<b>± 10%</b>	<b>8,4</b>	<b>30,6</b>
1018	18	710	± 10%	12,6	45,9
<b>1024</b>	<b>24</b>	<b>1 440</b>	<b>± 10%</b>	<b>16,8</b>	<b>61,2</b>
1036	36	3 140	± 10%	25,2	91,8
1048	48	5 700	± 10%	33,6	122,4
1060	60	7 500	± 10%	42,0	153,0
1110	110	25 200	± 10%	77,0	280,0

The data in bold type relate to the standard versions of the relays. ⑨ The coil parameters are given for 20 °C and a relay with no load on the contacts. See details in Figure 4: permissible operating voltage range of the coil - DC voltage.

**Coil data - AC 50/60 Hz voltage version**

Table 2

Coil code	Rated voltage V AC	Coil resistance at 20 °C Ω	Acceptable resistance	Coil operating range V AC 50 Hz	
				min. (at 20 °C)	max. (at 20 °C)
5012	12	100	± 10%	9,6	13,2
<b>5024</b>	<b>24</b>	<b>400</b>	<b>± 10%</b>	<b>19,2</b>	<b>28,8</b>
5048	48	1 550	± 10%	38,4	57,6
5060	60	2 600	± 10%	48,0	72,0
5110	110	8 900	± 10%	88,0	132,0
5115	115	9 600	± 10%	92,0	138,0
5120	120	10 200	± 10%	96,0	144,0
5220	220	35 500	± 10%	176,0	264,0
<b>5230</b>	<b>230</b>	<b>38 500</b>	<b>± 10%</b>	<b>184,0</b>	<b>276,0</b>
5240	240	42 500	± 15%	192,0	288,0

The data in bold type relate to the standard versions of the relays.

**Pinout (solder side view)**

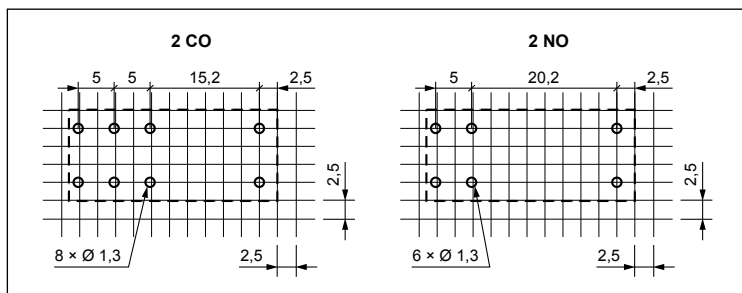

# RM84

## miniature relays

### Ordering codes

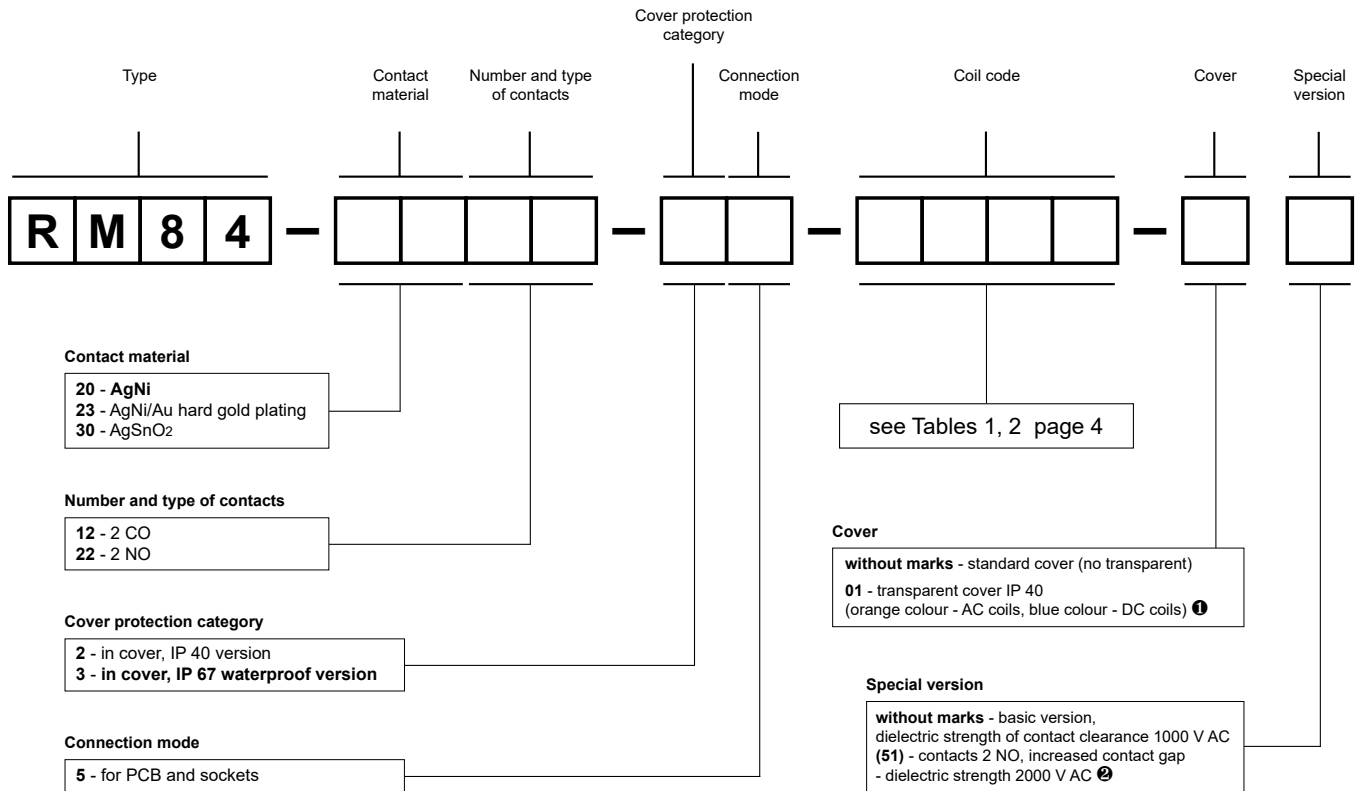

❶ 01: special version - relay in transparent cover (certifications cULus, EAC), only available with IP 40 and RTII, operating temperature -20...+70 °C  
 ❷ (51): special version - relay with two normally open contacts 2 NO, with increased contact gap - dielectric strength 2000 V AC, only available with DC coil

Examples of ordering code:

**RM84-3012-25-5024**

relay **RM84**, for PCB and sockets, two changeover contacts, contact material AgSnO<sub>2</sub>, coil voltage 24 V AC 50/60 Hz, in standard cover (no transparent) IP 40

**RM84-2012-25-1012-01**

relay **RM84**, for PCB and sockets, two changeover contacts, contact material AgNi, coil voltage 12 V DC, in transparent cover (blue colour) IP 40

**RM84-2322-35-1024 (51)**

relay **RM84**, special version with increased contact gap, for PCB and sockets, two normally open contacts, contact material AgNi/Au hard gold plating, coil voltage 24 V DC, in standard cover (no transparent) IP 67

### RM84

Transparent cover IP 40,  
certifications cULus, EAC  
(orange colour - AC coils,  
blue colour - DC coils)

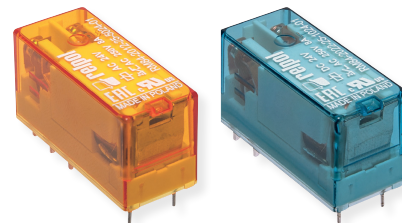

# Sockets and accessories

## GZT80

For RM84, RM85, RM85 inrush, RM85 105 °C sensitive, RM87L, RM87L sensitive, RM87P, RM87P sensitive

Screw terminals  
Max. tightening moment for the terminal: 0,7 Nm  
35 mm rail mount acc. to EN 60715 or on panel mounting  
80 x 15,6 x 61(67) mm  
Two poles, 5 mm pinout  
12 A, 300 V AC

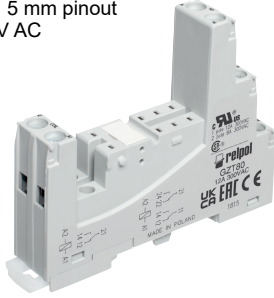

### Connection diagrams ③

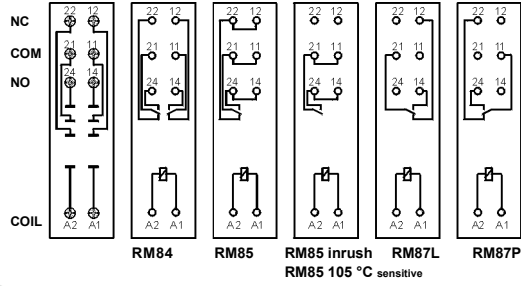

### Dimensions

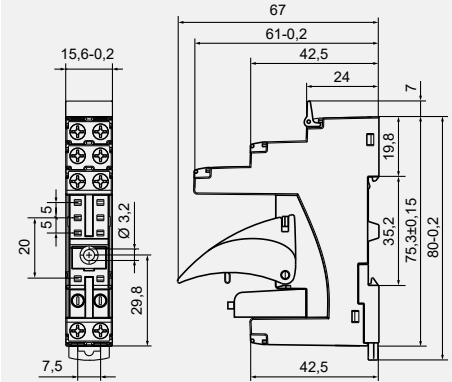

## GZM80

For RM84, RM85, RM85 inrush, RM85 105 °C sensitive, RM87L, RM87L sensitive, RM87P, RM87P sensitive

Screw terminals  
Max. tightening moment for the terminal: 0,7 Nm  
35 mm rail mount acc. to EN 60715 or on panel mounting  
81,6 x 15,9 x 61(67) mm  
Two poles, 5 mm pinout  
12 A, 300 V AC

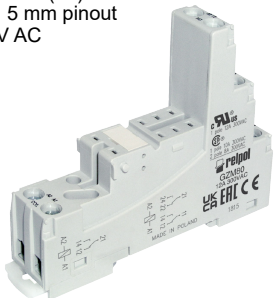

### Connection diagrams ③

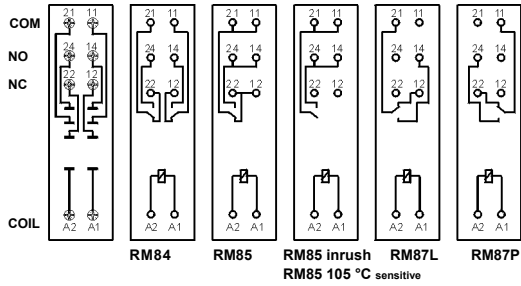

### Dimensions

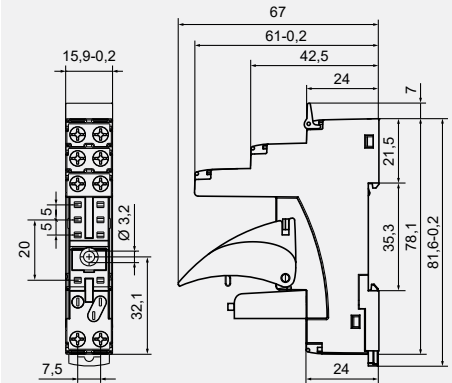

## GZS80

For RM84, RM85, RM85 inrush, RM85 105 °C sensitive, RM87L, RM87L sensitive, RM87P, RM87P sensitive

Screw terminals  
Max. tightening moment for the terminal: 0,5 Nm  
35 mm rail mount acc. to EN 60715 or on panel mounting  
76,8 x 15,8 x 42,5(57,1) mm  
Two poles, 5 mm pinout  
10 A, 300 V AC



### Connection diagrams ③

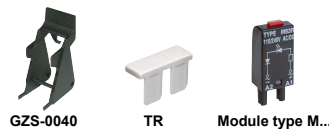
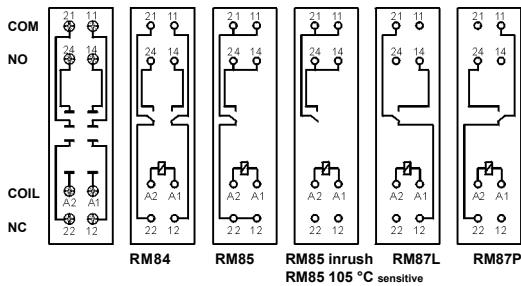

### Dimensions

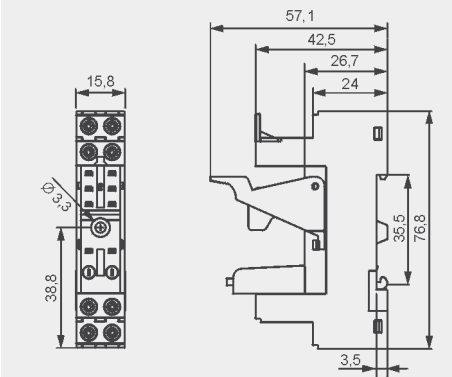

① Mounting and sub-assemblies of accessories in the socket - see page 8. Signalling / protecting modules type M... - see page 10. ② In the bracket the height of socket with retainer / retractor clip is shown. ③ For RM85..., RMP85: loads above 12 A (GZT80, GZM80, GZP80) or 10 A (GZS80, GZF80) require bridging pairs of terminals: 11 with 21, 12 with 22, 14 with 24 - see [www.repol.com.pl](http://www.repol.com.pl)

# Sockets and accessories

## GZP80

For RM84, RM85, RM85 inrush, RM85 105 °C sensitive, RM87L, RM87L sensitive, RM87P, RM87P sensitive, RMP84, RMP85

Push-in terminals (flammability class V-0)  
Max. cross section of the cables:  
2 x 1,5 mm<sup>2</sup> (ferrules without insulation)  
2 x 1 mm<sup>2</sup> (ferrules with insulation)  
Stripping length: 8... 10 mm

35 mm rail mount acc. to EN 60715 or on panel mounting  
97 x 15,9 x 45,9(75,8) mm  
5 mm pinout  
One pole 12 A, 300 V AC  
Two poles 8 A, 300 V AC



### Accessories

### Connection diagrams

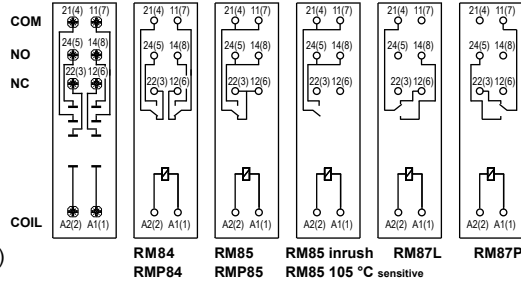

### Dimensions

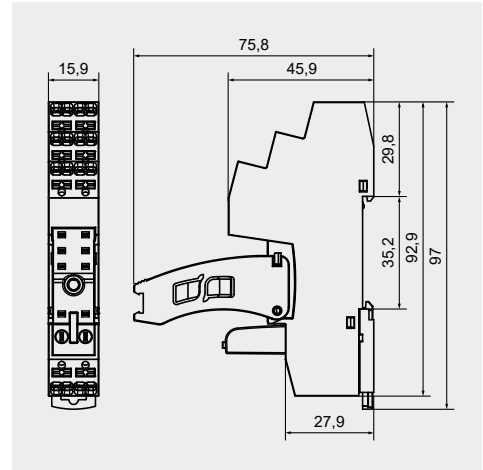

The drawings present inserting wire into the Push-in terminal and removing wire using the button releasing a clamp (assembly without tools).

### Wire connection

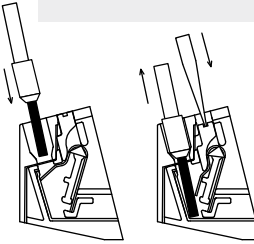

## GZF80

For RM84, RM85, RM85 inrush, RM85 105 °C sensitive, RM87L, RM87L sensitive, RM87P, RM87P sensitive, RMP84, RMP85

Screw terminals  
Max. tightening moment for the terminal: 0,5 Nm  
35 mm rail mount acc. to EN 60715 or on panel mounting  
67,2 x 15,5 x 36,5 mm  
Two poles, 5 mm pinout  
10 A, 250 V AC



### Connection diagrams

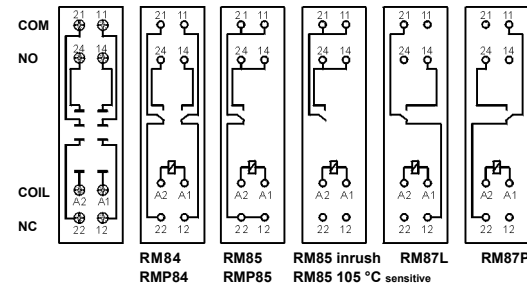

### Dimensions

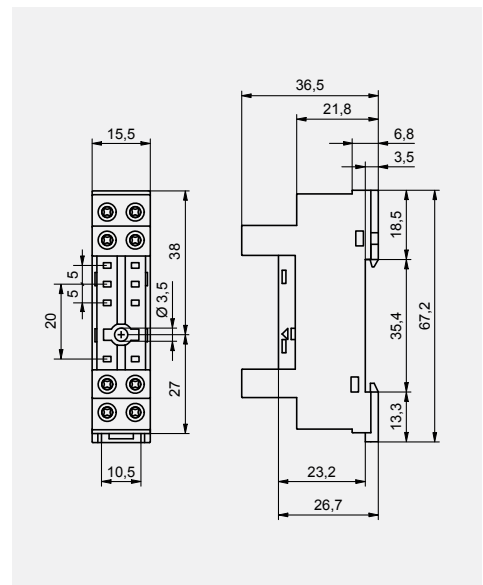

### Accessories

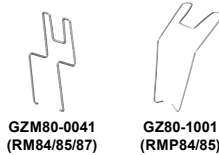

① Mounting and sub-assemblies of accessories in the socket - see page 8. Signalling / protecting modules type M... - see page 10. ② In the bracket the height of socket with retainer / retractor clip is shown. ③ For RM85..., RMP85: loads above 12 A (GZT80, GZM80, GZP80) or 10 A (GZS80, GZF80) require bridging pairs of terminals: 11 with 21, 12 with 22, 14 with 24 - see [www.repol.com.pl](http://www.repol.com.pl)



### Mounting and sub-assemblies of the relay and accessories in the socket

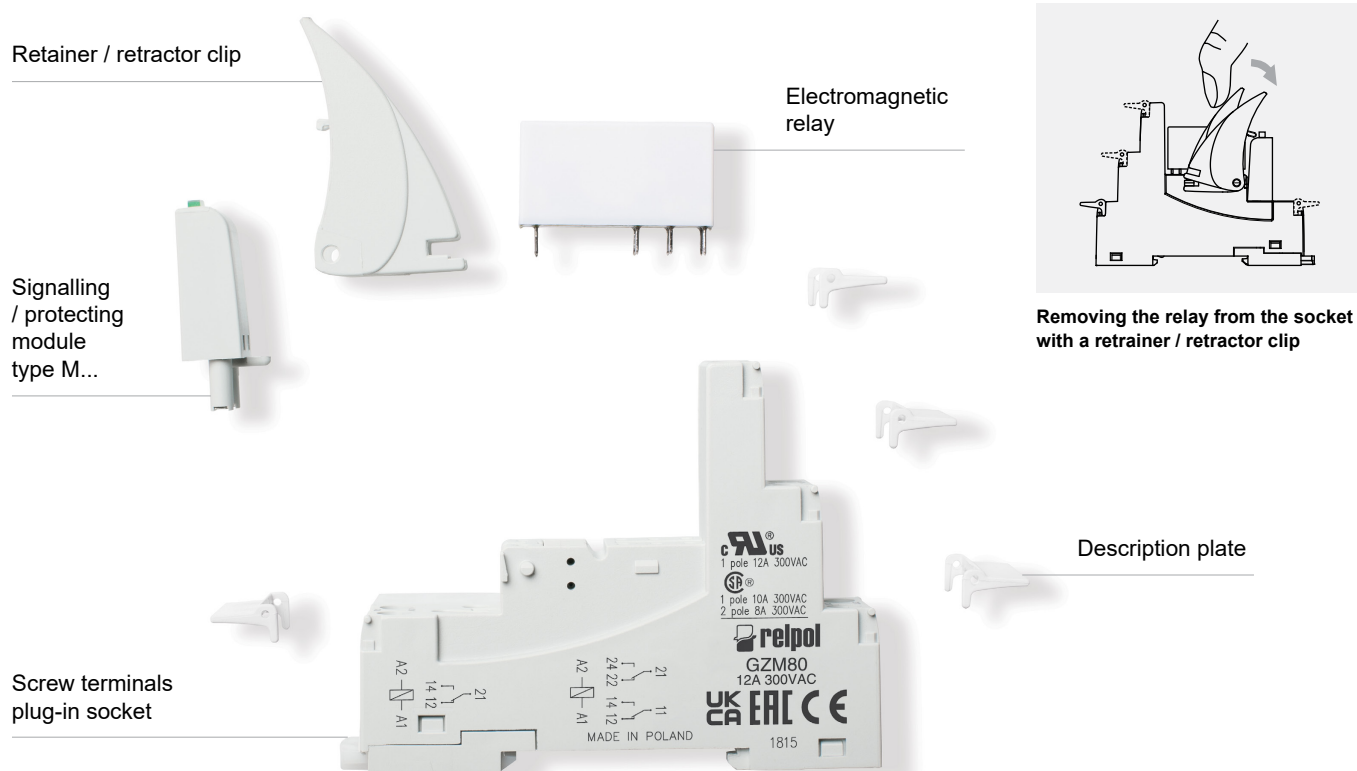

#### PRECAUTIONS:

1. Ensure that the parameters of the product described in its specification provide a safety margin for the appropriate operation of the device or system and never use the product in circumstances which exceed the parameters of the product. 2. Never touch any live parts of the device. 3. Ensure that the product has been connected correctly. An incorrect connection may cause malfunction, excessive heating or risk of fire. 4. In case of any risk of any serious material loss or death or injuries of humans or animals, the devices or systems shall be designed so to equip them with double safety system to guarantee their reliable operation.



# Sockets and accessories

## PW80

For RM84, RM85, RM85 inrush, RM85 105 °C sensitive, RM87L, RM87L sensitive, RM87P, RM87P sensitive, RM83

For PCB  
34,6 x 12,9 x 6,6 mm  
Two poles, 5 mm pinout  
12 A, 250 V AC

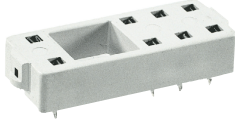

### Pinout

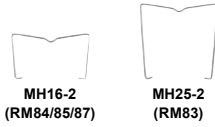
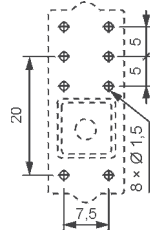

### Accessories

### Dimensions

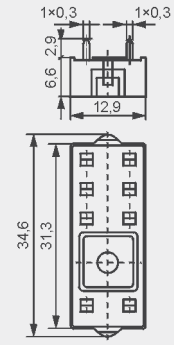

ERC

## EW50

For RM84, RM85, RM85 inrush, RM85 105 °C sensitive, RM87L, RM87L sensitive, RM87P, RM87P sensitive, RM83, RMP84, RMP85

For PCB  
30,2 x 13 x 9,4 mm  
Two poles, 5 mm pinout  
10 A, 250 V AC

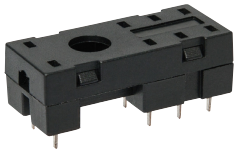

### Pinout

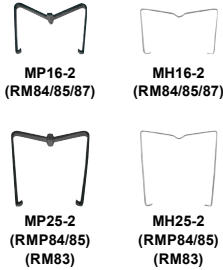
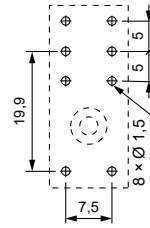

### Accessories

### Dimensions

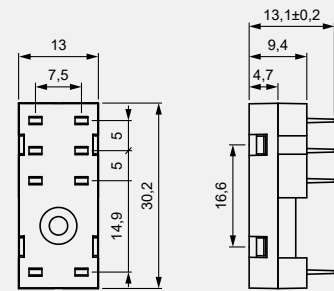

ERC

## EC 50

For RM84, RM85, RM85 inrush, RM85 105 °C sensitive, RM87L, RM87L sensitive, RM87P, RM87P sensitive, RM83, RMP84, RMP85

For PCB  
31,3 x 12,7 x 9 mm  
Two poles, 5 mm pinout  
12 A, 250 V AC

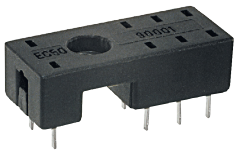

### Pinout

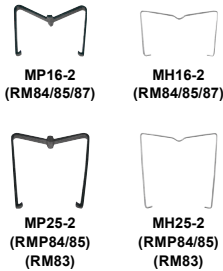
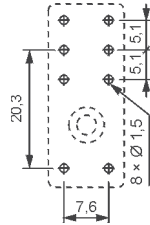

### Accessories

### Dimensions

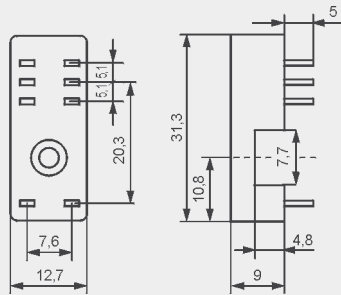

ERC

## GD50

For RM84, RM85, RM85 inrush, RM85 105 °C sensitive, RM87L, RM87L sensitive, RM87P, RM87P sensitive, RM83, RMP84, RMP85

For PCB  
31,5 x 13 x 9 mm  
Two poles, 5 mm pinout  
8 A, 300 V AC



### Pinout

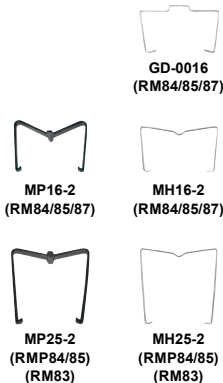
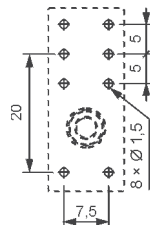

### Accessories

### Dimensions

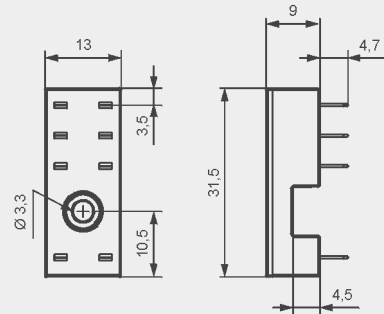

ERC

## Signalling / protecting modules type M...

### For sockets type:

GZT80, GZM80, GZS80, GZP80, GZT92, GZM92, GZS92, ES 32, GZT2, GZM2, GZT3, GZM3, GZT4, GZM4, GZP4

Modules type M... are parallelly connected with relay coil.

Polarization P: -A1/+A2. Polarization N: +A1/-A2.

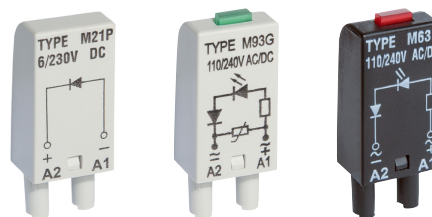

Modules type M...	Layout	Voltage	Type of module ① ②
<b>Module D (polarization P)</b> It limits overvoltage on DC coils.		6/230 V DC	M21P
<b>Module D (polarization N)</b> It limits overvoltage on DC coils.		6/230 V DC	M21N
<b>Module LD (polarization P)</b> It limits overvoltage on DC coils. Coil energizing indication.		6/24 V DC 24/60 V DC 110/230 V DC	M31R, M31G M32R, M32G M33R, M33G
<b>Module LD (polarization N)</b> It limits overvoltage on DC coils. Coil energizing indication.		6/24 V DC 24/60 V DC 110/230 V DC	M41R, M41G M42R, M42G M43R, M43G
<b>Module RC</b> It protects against EMC disturbance. It limits overvoltage.		6/24 V AC/DC 24/60 V AC/DC 110/240 V AC/DC	M51 M52 M53
<b>Module L</b> Coil energizing indication.		6/24 V AC/DC 24/60 V AC/DC 110/240 V AC/DC	M61R, M61G M62R, M62G M63R, M63G
<b>Module LV</b> It limits overvoltage on AC and DC coils. Coil energizing indication.		6/24 V AC/DC 24/60 V AC/DC 110/240 V AC/DC	M91R, M91G M92R, M92G M93R, M93G
<b>Module V</b> It limits overvoltage on AC coils. No indication.		6/24 V AC 110/130 V AC 220/240 V AC	M71 M72 M73
<b>Module R</b> It limits harmful voltage on AC coils induced in long lines which causes unwanted making of the relay.		110/240 V AC	M103

① M...R - LED red, M...G - LED green

② When ordering modules indicate their color: gray or black.

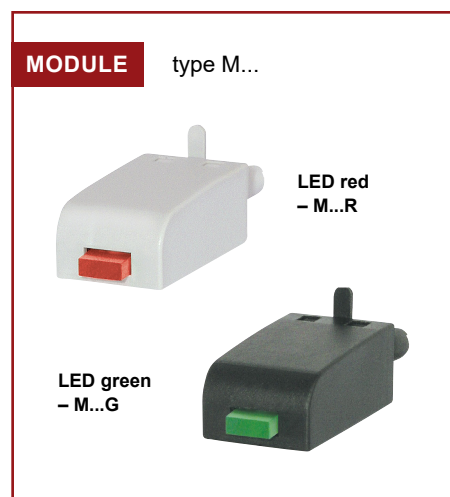

## Interconnection strips ZGGZ80



PI85-...-MS-...  
(RM85 + GZM80)

ZGGZ80

### ZGGZ80 for:

Plug-in sockets	Relays for plug-in sockets	Interface relays ③
GZT80	RM84, RM85, RM85 inrush, RM85 105 °C sensitive, RM87L ④, RM87P ④, RM87N ④	PI84-...-TS-... (RM84 + GZT80)
GZM80		PI84-...-MS-... (RM84 + GZM80)
GZS80		PI85-...-TS-... (RM85 + GZT80)
GZT92		(RM85 inrush + GZT80)
GZM92		PI85-...-MS-... (RM85 + GZM80)
GZS92		
ES 32	RM96 1 CO	

③ Interface relay **PI84 (PI85)** is offered as a **set**: electromagnetic relay **RM84 (RM85)** + plug-in socket **GZT80** or **GZM80** + signalling / protecting module type **M...** + retainer / retractor clip **GZT80-0040** + description plate **GZT80-0035**. ④ Also versions RM87. sensitive

### Interconnection strip ZGGZ80

- designed for the co-operation with plug-in sockets of miniature relays and with interface relays PI84 and PI85, which are equipped with screw terminals; sockets and relays are mounted on 35 mm rail mount acc. to EN 60715,
- bridges common input signals (coil terminals A1 or A2) or output signals - see photo at the top,
- maximum permissible current is 10 A / 250 V AC,
- possibility of connection of 8 sockets or relays,
- colours of strips: **ZGGZ80-1** grey, **ZGGZ80-2** black.

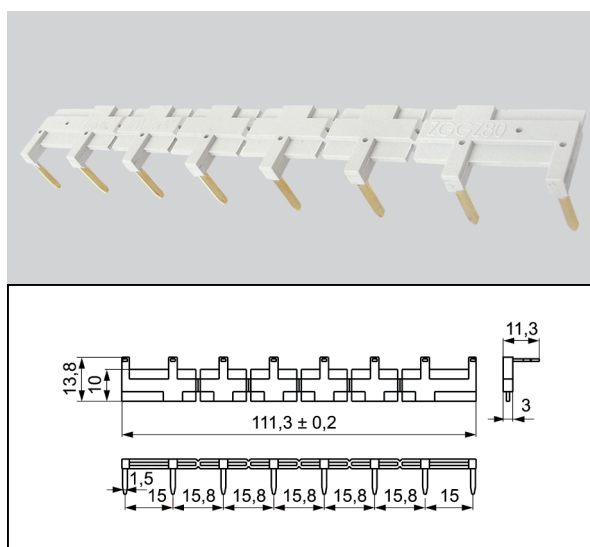

# Interconnection strips ZGZP... for sockets GZP80

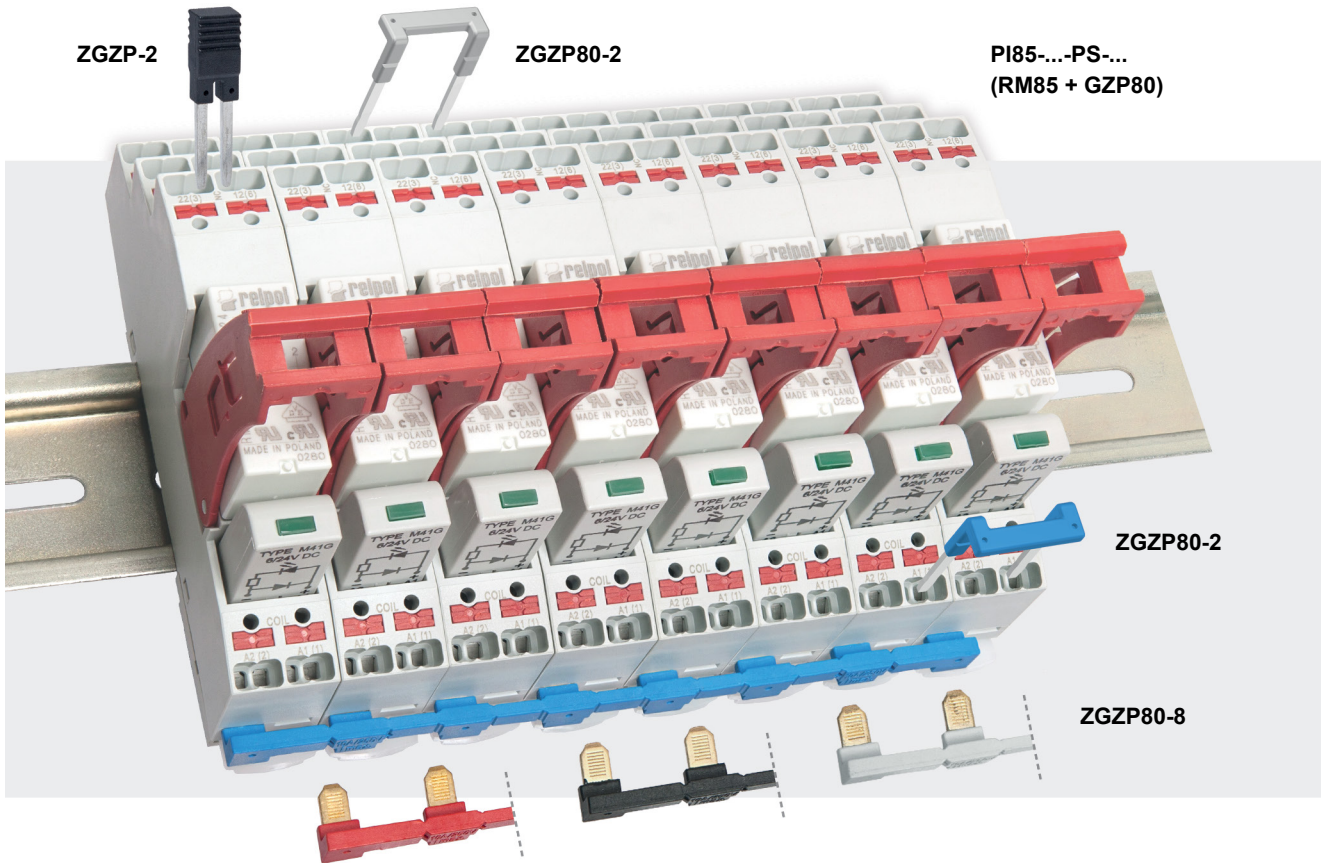

## ■ ZGZP... for:

Plug-in sockets	Relays for plug-in sockets	Interface relays ⑤
GZP80	RM84, RM85, RM85 inrush, RM85 105 °C sensitive, RM87L ④, RM87P ④, RMP84, RMP85	PI84-...-PS-... (RM84 + GZP80) PI85-...-PS-... (RM85 + GZP80) PI84P-...-PS-... (RMP84 + GZP80) PI85P-...-PS-... (RMP85 + GZP80)

⑤ Interface relay **PI84** (**PI85**, **PI84P**, **PI85P**) is offered as a **set**: electromagnetic relay **RM84** (**RM85**, **RMP84**, **RMP85**) + plug-in socket **GZP80** + signalling / protecting module type **M...** + retainer / retractor clip **GZP80-0400**.  
④ Also versions RM87. sensitive

## ■ Interconnection strips ZGZP...

- designed for the co-operation with plug-in sockets of miniature relays and with interface relays PI84, PI85, PI84P, PI85P, which are equipped with Push-in terminals; sockets and relays are mounted on 35 mm rail mount acc. to EN 60715,
- strip **ZGZP80-8** bridges common input signals (coil terminals A1 or A2), maximum permissible current is 10 A / 250 V AC, possibility of connection of 8 sockets or relays,



- strip **ZGZP80-2** bridges common input signals (coil terminals A1 or A2) or output signals, possibility of connection of 2+n sockets or relays,



- jumper **ZGZP-2** bridges the neighboring poles of single socket **GZP80** (usage of jumpers ZGZP-2 in interface relays Push-in PI85, PI85P increases load capacity of socket from 12 A to 16 A).

